

Model A-Series

PROTECTOR



Description

The Model A-Series PS007/PS008 (Glass Bulb Type) Standard Orifice standard and quick response. The A-Series Conventional Sprinkler Identification Number (SIN) PS007(standard) PS008(quick). The design incorporates state-of-the-art, heat responsive, frangible glass bulb design (standard or quick response) for prompt, precise operation. The die cast frame is more streamlined and attractive than traditional sand cast frames. It is cast with a hex-shaped wrench to allow easy tightening from different angles. This sprinkler is available in various temperature ratings (see Chart on Page.4) and finishes to meet many design requirements. The recessed Pendant should be utilized with a Model A recessed escutcheon which provides up 3/4" of adjustments. All Protector Sprinklers are manufactured using the time proven Belleville seal used exclusively by all major manufactures to ensure long life and safe operation.



Horizontal Sidewall

PS008

Maximum Coverage

Standard spray coverage is up to: Light Hazard = 196 square feet(18.2 sq.m); Ordinary Hazard = 100 square feet(9.3 sq.m) per NFPA 13. See Chart on Page.4 for distribution patterns.

Operation

The operating mechanism is a frangible glass bulb which contains a heat responsive liquid. During a fire, the ambient temperature rises causing the liquid in the bulb to expand. When the ambient temperature reaches the rated temperature of the sprinkler, the bulb shatters. As a result, the waterway is cleared of all sealing parts and water is discharged towards the deflector. The deflector is designed to distribute the water in a pattern that is most effective in controlling the fire.

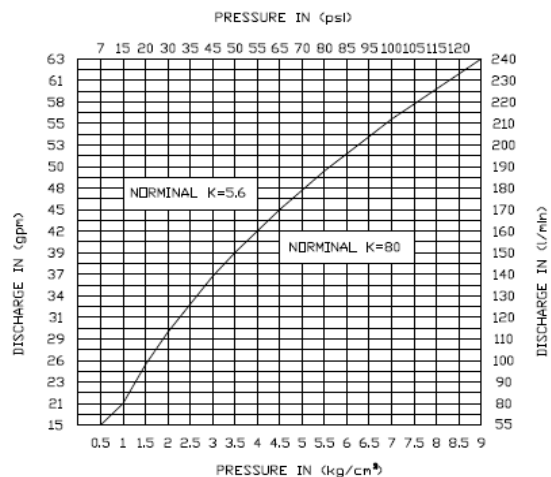

Warnings

The Protector Model A-Series must be installed and maintained in compliance with this document.

Depressurize and drain the piping system before attempting to install, remove, or adjust any Protector Sprinklers.

Failure to do so may impair the performance of these sprinklers.

The owner is responsible for maintaining the fire protection system and devices in operation.

Technical Specification

| | |
|---------------------------|-------------------------|
| Model SIN: | PS007 Standard Response |
| | PS008 Quick Response |
| Style: | PS007, PS008 |
| K-Factor: | 5.6Imp(80S.I) |
| RTI: | Standard 50, Quick 30 |
| Approvals: | See Chart on Page.4 |
| Nominal Working Thread: | 1/2" NPT (15mm) |
| Max. Working Pressure: | 175PSI (1200kPa) |
| Factory Hydrostatic Test: | 100% @ 500PSI (3450kPa) |
| Min. Operating Pressure: | 7PSI (48kPa) |
| Temperature Rating: | See Chart on Page.4 |

Dimensions

PROTECTOR

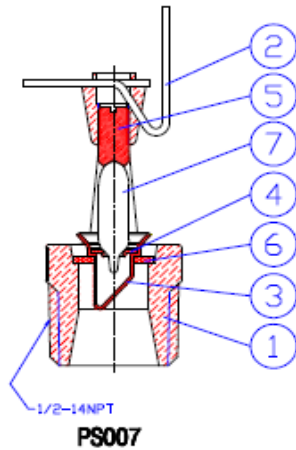

PS007

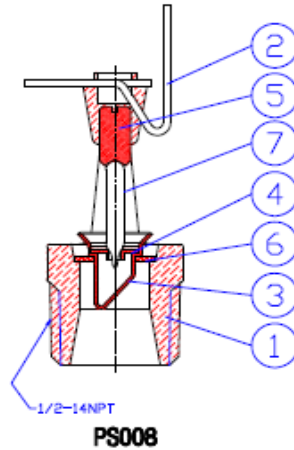

PS008

| | | | |
|---|------------------|---|---------------------------------|
| 1 | 滅火器 BULB | 7 | NORBULB N5 |
| 1 | 彈片 SEAL | 6 | BERY. NIOBEL SPRING TEFLON TAPE |
| 1 | 螺絲 LOAD SCREW | 5 | ASTM C36000 |
| 1 | 內螺絲帽 OR CAP SEAT | 4 | ASTM S30400 |
| 1 | 內螺絲帽 CAP | 3 | ASTM C11000 |
| 1 | 噴嘴 DEFLECTOR | 2 | ASTM C22000 |
| 1 | 本體 FRAME | 1 | ASTM C37700 |

| | | | |
|---|------------------|---|---------------------------------|
| 1 | 滅火器 BULB | 7 | NORBULB N3 |
| 1 | 彈片 SEAL | 6 | BERY. NIOBEL SPRING TEFLON TAPE |
| 1 | 螺絲 LOAD SCREW | 5 | ASTM C36000 |
| 1 | 內螺絲帽 OR CAP SEAT | 4 | ASTM S30400 |
| 1 | 內螺絲帽 CAP | 3 | ASTM C11000 |
| 1 | 噴嘴 DEFLECTOR | 2 | ASTM C22000 |
| 1 | 本體 FRAME | 1 | ASTM C37700 |

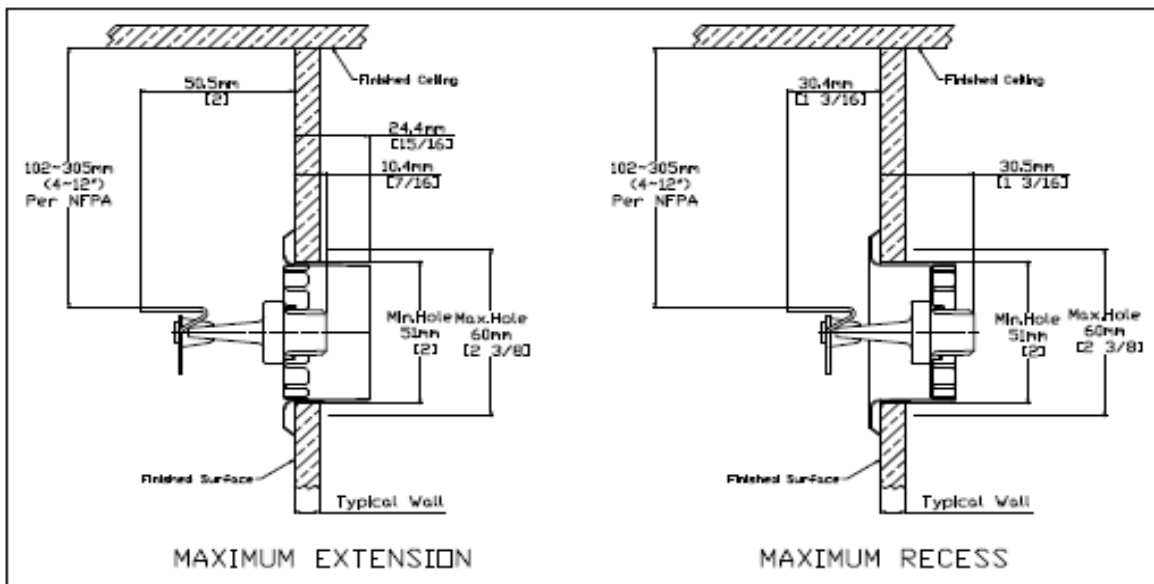
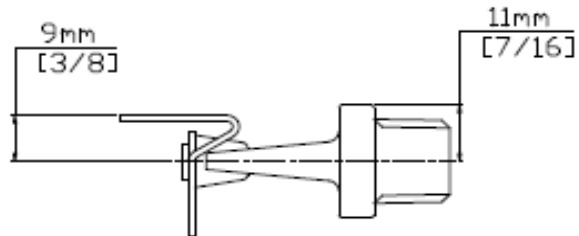
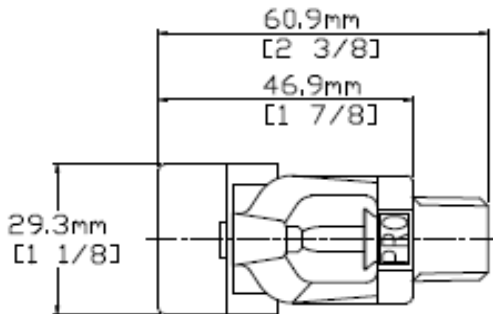

1/2" ADJUSTMENT

Wrench Description

The Sprinkler Wrench is a tool specifically designed for installing PROTECTOR Sprinklers. These special wrenches must be used to provide the proper leverage when tightening the sprinkler and to minimize slippage during installation. Any other wrench may damage the sprinkler. The following wrenches are available for installing PROTECTOR Sprinklers.



**PROTECTOR SPRINKLER
WRENCH**

Installation

All PROTECTOR Sprinklers must be installed according to NFPA 13 Standards. Deviations from these requirements and standards or any alteration to the sprinkler itself will void any warranty made by PROTECTOR Sprinkler Company. In addition, installation must also meet local government provisions, codes and standards as applicable.

The system piping must be properly sized to insure the minimum required flow rate at the sprinkler. Check for the proper model, style, orifice size and temperature rating prior to installation. Install sprinklers after the piping is in place to avoid mechanical damage, replace any damaged units. Wet pipe systems must be protected from freezing.

Upon completion of the installation, the system must be tested per recognized standards. In the event of a thread task, remove the unit, apply new pipe joint compound or tape, and reinstall.

Additional

Recessed Sprinkler - To install the escutcheon plate, align with it and push or thread over the sprinkler body into the upper support piece, until the outer edge of the escutcheon meets the mounting surface.

Installation Sequence

Step 1. The unit must be installed in the horizontal sidewall position for the Horizontal Sidewall Sprinklers.

Step 2. Use only a non-hardening pipe joint compound or tape seal. Apply only to the male threads.

Step 3. Hand tighten the sprinkler into fitting.

Step 4. For Horizontal Sidewall Sprinklers, use a standard wrench. Tighten the unit into the fitting. A lead-tight joint requires only 7 to 14ft.-lbs(9.5 to 19.0Nm) of torque. A tangential force of 14 to 28ft.-lbs(62.3 to 124.5N) delivered through a 6"(150mm) handle will deliver adequate torque. Once torque level reach over 21ft.-lbs(28.6Nm) it may distort the orifice seal, resulting in leakage. For exposed piping systems, the sprinkler should be oriented so the frame arms are parallel with the branch line pipe.

Caution

Do not over-tighten or under-tighten the sprinkler to compensate for inaccurate escutcheon plate adjustment.

Protection clips are used to protect its bulb. Please have clip on at all times during transportation.

Maintenance

Sprinklers must never be altered after manufacture. Any alteration such as painting and coating will directly harm the sprinkler and cause malfunctions.

Sprinkler in contact with corrosive products should be replaced if they cannot be cleaned completely.

Visual inspections are recommended after installation. After installation, a close-up inspection annually will suffice.

Inspection and maintenance of fire protection system is the responsibility of the owner. It is recommended that automatic sprinkler system be inspected and tested according to local and/or

Approvals and Listings

| Nominal Size Inches/mm | | K-Factor Imperial S.I. | Response | Sprinkler Type | Approvals | | |
|---------------------------|---------|---------------------------|----------|-------------------|-----------|------|-----|
| Thread | Orifice | | | | UL | C-UL | CNS |
| 1/2/15 | 1/2/13 | 5.6/80 | Standard | Hori. Sidewall | Yes | Yes | Yes |
| 1/2/15 | 1/2/13 | 5.6/80 | Standard | Recessed | Yes | Yes | Yes |
| 1/2/15 | 1/2/13 | 5.6/80 | Quick | Hori. Sidewall | Yes | Yes | Yes |
| 1/2/15 | 1/2/13 | 5.6/80 | Quick | Recessed | Yes | Yes | Yes |

Temperature Ratings

| Sprinkler Temperature Classification | Nominal Sprinkler Temperature Rating | N.F.P.A. Maximum Ambient (Ceiling) Temp. Allowed | Glass Bulb Color |
|--------------------------------------|--------------------------------------|--|------------------|
| Ordinary | 135°F/57°C | 100°F/38°C | Orange |
| | 155°F/68°C | 100°F/38°C | Red |
| Intermediate | 175°F/79°C | 150°F/65°C | Yellow |
| | 200°F/93°C | 150°F/65°C | Green |
| High | 286°F/141°C | 225°F/107°C | Blue |
| Extra High | 360°F/182°C | 300°F/149°C | Mauve |
| Open | Open | - | No Bulb |

Distribution Patterns - Trajectory

K5.6 Standard Horizontal Sidewall and Recessed - Trajectory

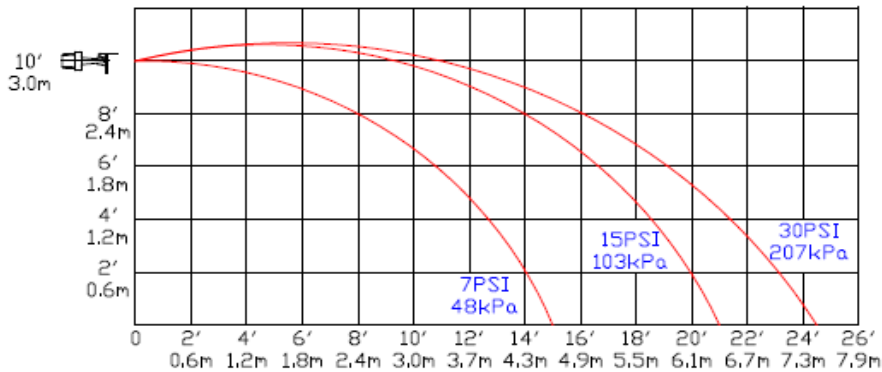

K5.6 Standard Horizontal Sidewall and Recessed - Plain View

