

FLASHING LIGHTS & EVACUATE SIGN

Model D-124B
Model D-124L

Model D-104 WP
Model D-104 WP/L

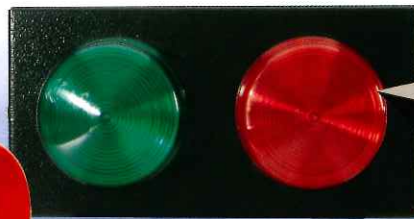

Model D-104B
Model D-104L



*B - Filament Bulb / L - Ultra Bright LED

DEMCO ADVANTAGES

- Durable - Tough industrial design constructed with mild steel.
- Accessible - Removable conduit plug offers easy conduit entries.
- Versatile - Suitable for surface or flush mounting.
- Optional Hood - Model D-104WP only. Suitable for outdoor application.
- Luminary: Filament Bulb & Ultra Bright LED
- Operating Voltage: 24V DC
- Operating Currents: 120mA - Bulb
20mA - LED
- Flashing Rate: 1 Flash per sec @ 24V - Bulb
2 Flash per sec @ 24V - LED

Model D-124B or D-124L

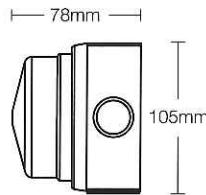
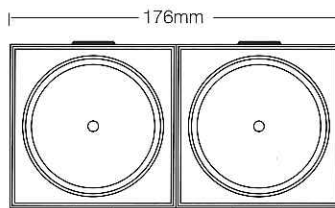

Model D-104 WP or D-104 WP/L

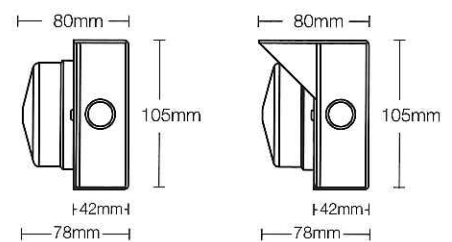
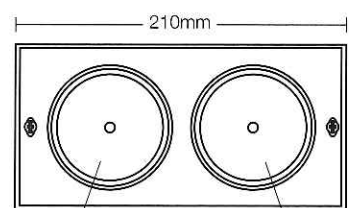

Model D-154B
Model D-154L

Single Flashing Light

- Dimension: 88 (W) x 88 (H) x 72mm (D)
- Body: Red or Black ABS Plastic
- Prismatic Lens: Green or Red Polycarbonate
- Luminary available in Filament Bulb or Ultra Bright LED
- Optional Feature: Built-in Buzzer
- Operating Voltage: 24V DC
- Operating Currents: 120mA - Bulb
20mA - LED

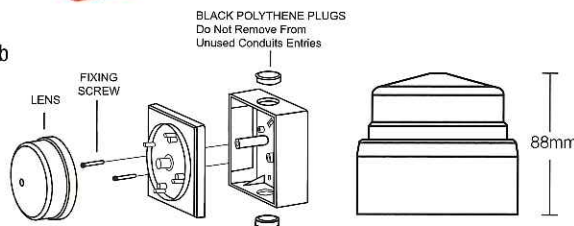
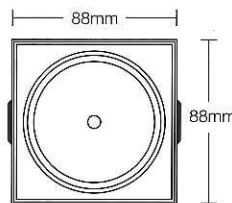

Model D-115-154L

- Beacon / Sounder Combination
- Operating Voltage: 24V DC
 - Operating Current: 70mA

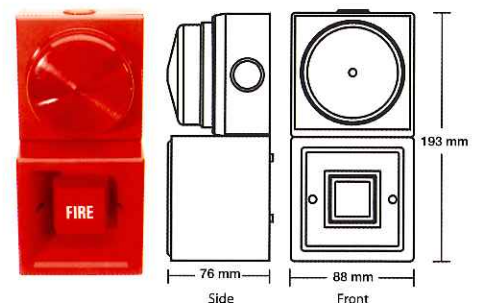

Model D-110B
Model D-110L

Evacuate Sign

- Dimension: 260 (W) x 110 (H) x 80mm (D)
- Casing: Mild Steel
- Colour: Black
- Luminary: Filament Bulb or Ultra Bright LED
- Custom Imprint
- Operating Voltage: 24V DC
- Operating Current: 240mA - Bulb
20mA - LED

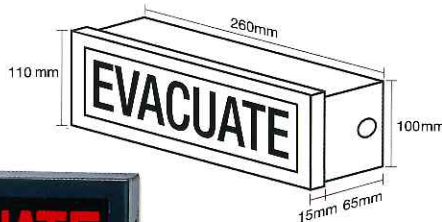

Net Weight
Model D-110B & D-110L: 1230g



Lot 3928, Jalan Keretapi Lama
Off Jalan Kapar 5 1/2 Miles
42100 Klang
Selangor Darul Ehsan
West Malaysia
Tel: 603-3290 3333
Fax: 603-3290 2288
E-mail: sales@demcoalarm.com
demco@tm.net.my



Specifications are subject to change

Quality without Compromise